

FIȘA TEHNICĂ
SCHEMA DATI
ТЕХНИЧЕСКАЯ СПЕЦИФИКАЦИЯ
ADATLAP
ЛИСТ С ДАННИ
DÁTOVÝ HÁROK

RITMO

Art. 01-3769

EN - Indoor ceiling lamp, equipped with SMD LEDs, with the possibility of selecting the color temperature of the light, metal and aluminum structure painted in matt gold, opal white silicone diffusers.

RO - Plafonieră pentru interior, echipată cu LED-uri SMD, cu posibilitate de selectare a temperaturii de culoare a luminii, structură din metal și aluminiu vopsit aur mat, dispersoare din silicon alb opal.

IT - Plafoniera per interni, dotata di LED SMD, con possibilità di selezionare la temperatura di colore della luce, struttura in metallo e alluminio verniciato oro opaco, diffusori in silicone bianco opale.

RU - -

HU - -

BG - -

SK - -

Product type	Ceiling lamp
Input voltage	220-240V, 50/60Hz
Power	40W
Led type	252 pcs x 0,15W, 3000K + 252pcs x 0,15W, 4000K, 2835 SMD LED
Color temperature	CCT by back switch 3000K - 4000K
Led luminous flux	5141 lm
System luminous flux	2215 lm
CRI	80
OPTICS	-
Dimmable	No
Øuse (lm)	5141
Pon (w)	40
FTM	0.926
ηTM	119.01
Energy efficiency class	E
Warranty (years)	3
Protection class	Class I
IP rating	IP20

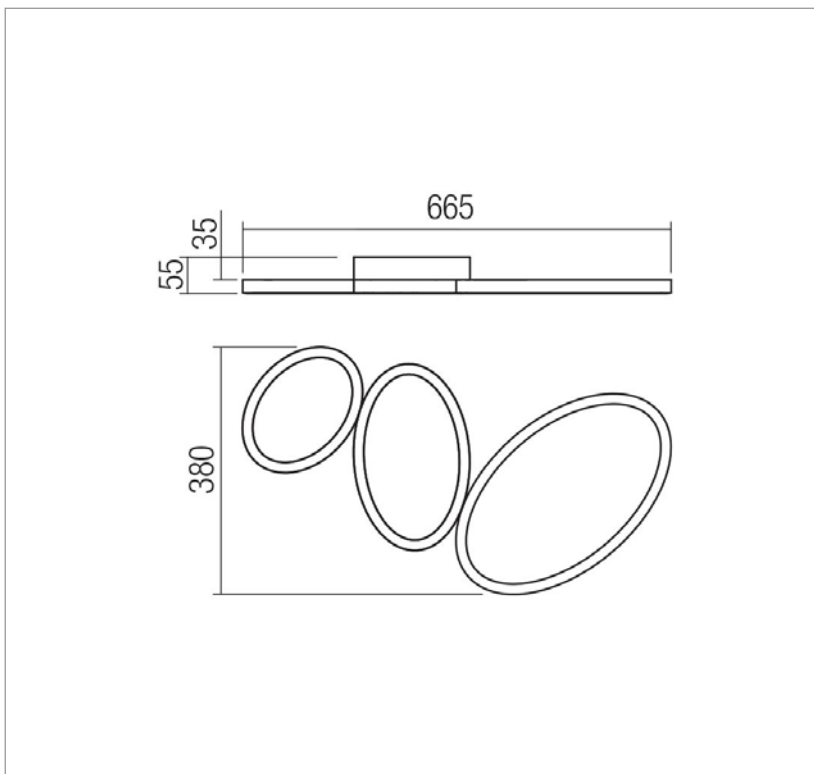
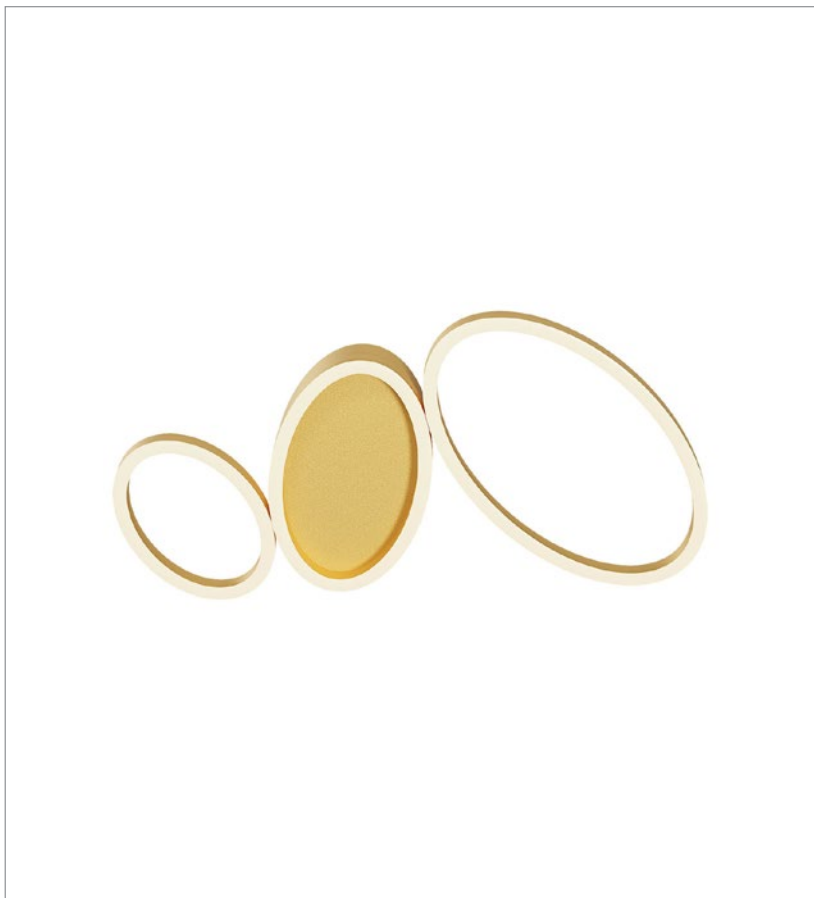

LED removal by a specialist **YES**
Driver removal by a specialist **YES**

Standards: EN 60598-1:2015 + A1:2018, EN 60598-2-1:2020, EN 60598-2-2:2012, EN 62493:2015, EN 62471:2008, EN 62031:2008 + A1:2013 + A2:2015, EN 60529:1992 + A2:2013, EN 55015:2019 + A11:2020, EN 61000-3-2:2019, EN 61000-3-3:2013 + A1:2019, EN 61547:2009.
Made in PRC.