

# SPOT- LIGHTS

# Cameo



**Series of lamps for interior, structure and diffuser of die cast aluminium electrostatically painted in mat white or mat black.**



04-468

RO - Serie de corpuri pentru interior, structură și dispersor din aluminiu turnat sub presiune vopsite în câmp electrostatic alb mat sau negru mat.

IT - Serie di apparecchi per interni, struttura e paralume in pressofusione di alluminio verniciati a polveri bianco opaco o nero opaco.

RU - Серия светильников для интерьера, структура и рассеиватель из алюминия литого под давлением окрашены в электростатическом поле в белый матовый или черный матовый цвет.

HU - Beltéri lámpatestek, elektrosztatikus mezőben matt fehér vagy matt feketére festett, nyomás alatt öntött alumínium szerkezet és ernyő.

BG - Серия от интериорни осветителни тела, основа и дифузер от лят алуминий, электростатично боядисан в бял мат или черен мат.

SK - Sériá svietidiel pre interiér, konštrukcia a difúzor z liateho hliníka elektrostáticky lakovaná v matnej bielej alebo matnej čiernej farbe.

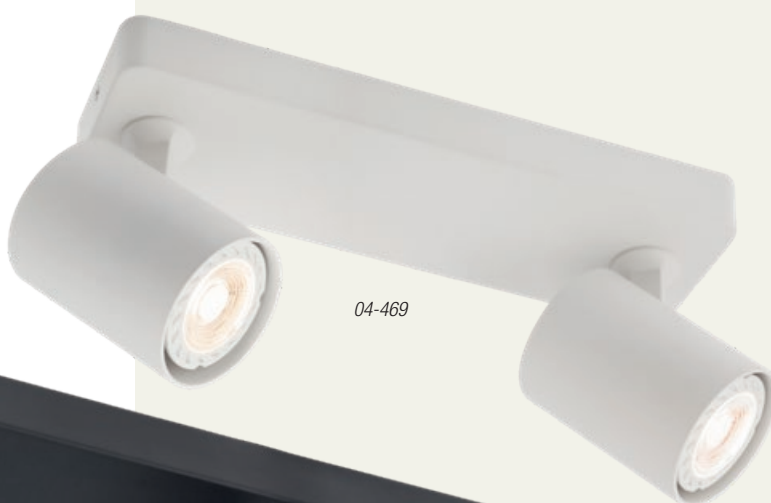

04-469



04-474



04-471



04-474

## INFO/DIMENSIONS

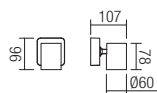

- 04-467 Mat White
- 04-468 Mat Black

GU10, 1 x max. 35W

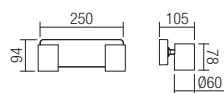

- 04-469 Mat White
- 04-470 Mat Black

GU10, 2 x max. 35W

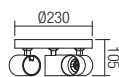

- 04-471 Mat White
- 04-472 Mat Black

GU10, 3 x max. 35W

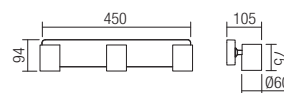

- 04-473 Mat White
- 04-474 Mat Black

GU10, 3 x max. 35W



# Vertigo



**Indoor spotlights, chromed metal structure, diffuser of mat white painted metal with circular decorative perforations.**

RO - Corpuri de iluminat pentru interior, structură din metal cromat, dispersor din metal vopsit alb cu perforații decorative circulare.

IT - Apparecchi di illuminazione per interni, struttura in metallo cromato, diffusore in metallo verniciato bianco opaco con perforazioni decorative circolari.

RU - Светильники для интерьера структура из хромированного металла, рассеиватель из окрашенного в белый цвет матового металла с круглыми декоративными перфорациями.

HU - Beltéri lámpa testek, króm fémszerkezet, fehér fém diszperzór, kör dísz kivágásokkal.

BG - Интериорни насочващи осветителни тела, корпус от хромиран метал, дифузер от метал в цвят бял мат, с кръгли декоративни перфорации.

SK - Interiérové spotové svietidlá, chrómová štruktúra, difúzor v matnej bielej farbe s kruhovými dekoráciami.



04-509



04-507



04-508



04-506

INFO/DIMENSIONS



04-506

E14, 1 x max. 28W

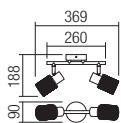

04-507

E14, 2 x max. 28W

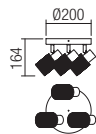

04-508

E14, 3 x max. 28W

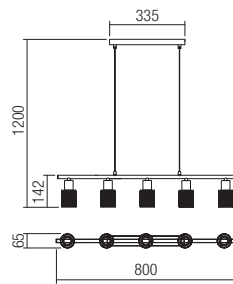

04-509

E14, 5 x max. 28W



# Basket



**Series of light fixtures for interior, metal structure painted in sand black and natural wood resembling decorations, fretted bronze shades. Bulbs not included.**

RO · Serie de corpuri de iluminat pentru interior, structură din metal vopsit negru mat cu decorațiuni finisate tip lemn natur, abajururi din metal traforat bronz. Becurile nu sunt incluse.

IT · Serie di apparecchi per interni, struttura in metallo nero opaco con decorazioni verniciate tipo legno naturale, paralumi in metallo traforato finitura bronzo. Lampadine non incluse.

RU · Серия светильников для интерьера, структура из металла, покрашенного в матовый черный, с отделкой в виде декоративных украшений, похожих на натуральное дерево, с металлическими абажурами, отделанными под лепную бронзу. Лампочки не включены.

HU · Beltéri lámpa testek, matt fekete fém szerkezet natúr fa diszítéssel, bronz színű fém ernyő. Az izzó nem tartozék.

BG · Серия осветителни тела за интериор, метална структура, боядисана в матово черно, декорации със завършек от тип естествено дърво, абажури от бронзов перфориран метал. Крушките не са включени.

SK · Sériá interiérových svietidiel, kovová konštrukcia lakovaná pieskovou čiernou s prírodnými drevenými ozdobami. Žiarovky nie sú súčasťou balenia.



04-519



04-520

## INFO/DIMENSIONS

**04-519**

E27, 1 x max. 42W

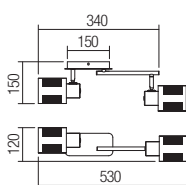
**04-520**

E27, 2 x max. 42W

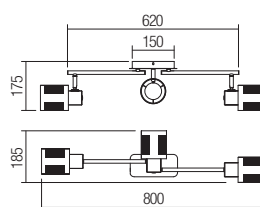
**04-521**

E27, 3 x max. 42W

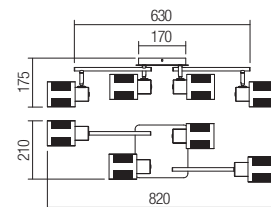
**04-522**

E27, 4 x max. 42W





04-521



04-522

# Pons



Light fixtures for interior, metal structure painted in mat black with chromed details, fretted rose gold shades. Bulbs not included.

RO - Corpuri de iluminat pentru interior, structură din metal vopsit negru mat cu detalii cromate, abajururi din metal traforat finisat aur roz. Becurile nu sunt incluse.

IT - Apparecchi luminosi per interni, struttura in metallo nero opaco con dettagli cromati, paralumi in metallo traforato finitura oro rosa. Lampadine non incluse.

RU - Светильники для интерьера, структура из металла, покрашенного в матовый черный с хромированными деталями, с металлическими абажурами, отделанными под лепное золото. Лампочки не включены.

HU - Beltéri lámpa testek, matt fekete fém szerkezet króm diszítéssel, arany színű fém ernyő. Az izzó nem tartozék.

BG - Осветелителни тела за интериор, метална структура, боядисана в матово черно, с хромирани детайли, абажури от перфориран метал с розово злато завършек. Крушките не са включени.

SK - Interiérové svietidlá, kovová konštrukcia lakovaná v matnej čiernej farbe s chrómovanými detailami, s odtieňmi ružového zlata. Žiarovky nie sú súčasťou balenia.

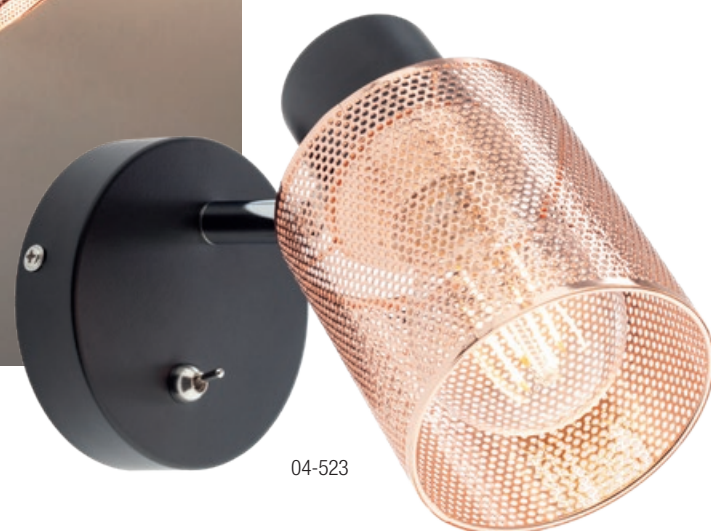

04-523

## INFO/DIMENSIONS

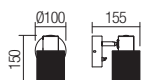

04-523

E27, 1 x max. 42W

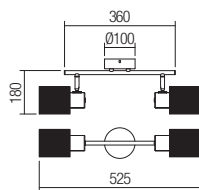

04-524

E27, 2 x max. 42W

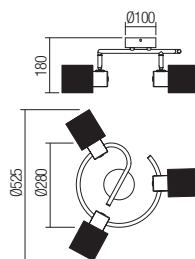

04-525

E27, 3 x max. 42W

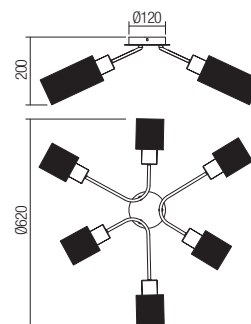

04-526

E27, 6 x max. 42W







04-524



04-525



04-526

# Ronin

Series of light fittings for interior, metal structure electrostatically painted in black with fretted copper plated metal diffusers.

RO · Serie de lămpi pentru interior, structură din metal vopsit în câmp electrostatic negru cu dispersoare din metal traforat finisaj cupru.

IT · Serie di lampade per interni, struttura in metallo verniciato a polveri nero, diffusori in metallo traforato finitura rame.

RU · Серия светильников для интерьера, металлическая конструкция окрашенная в электростатическом поле в черный цвет с рассеивателями из тесненного металла с медной отделкой.

HU · Beltéri világítótestek, elektrosztatikus mezőben festett fekete fémszerkezet, réz diszperzór.

BG · Серия интериорни осветителни тела, метална структура електростатично боядисана в черно с прояден метален разсейвател с медно покритие.

SK · Sériá interiérových svietidiel, kovová konštrukcia lakovaná v čiernej farbe, s medenými difúzormi.



## INFO/DIMENSIONS

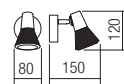

**04-456**

E14, 1 x max. 28W

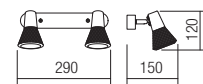

**04-457**

E14, 2 x max. 28W

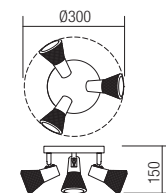

**04-458**

E14, 3 x max. 28W

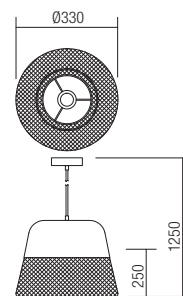

**04-459**

E27, 1 x max. 42W





04-459



# Torn



**Light fixtures for interior, metal structure painted in mat black with bronze details, fretted bronze shades. Bulbs not included.**



04-516

RO · Corpuri de iluminat pentru interior, structură din metal vopsit negru mat cu detalii bronz, abajururi din metal traforat finisat bronz. Becurile nu sunt incluse.

IT · Apparecchi per interni, struttura in metallo nero opaco con dettagli bronz, paralumi in metallo traforato finitura bronz. Lampadine non incluse.

RU · Светильники для интерьера, структура из металла, покрашенного в матовый черный с бронзовыми деталями, с металлическими абажурами, отделанными под лепное золото. Лампочки не включены.

HU · Beltéri lámpa testek, matt feketé fém szerkezet bronz díszítéssel, bronz színű fém ernyő. Az izzó nem tartozék.

BG · Осветителни тела за интериор, метална структура, боядисана в матово черно, с бронзови детайли, абажури от перфориран метал с бронзов завършек. Крушките не са включени.

SK · Interiérové svietidlá, kovová konštrukcia lakovaná v matnej čiernej farbe s bronzovými detailami, s bronzovými odtieňmi. Žiarovky nie sú súčasťou balenia.



04-517



04-517



04-518

## INFO/DIMENSIONS

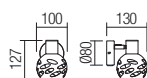
**04-516**

E14, 1 x max. 28W

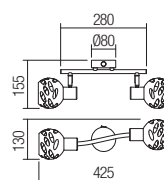
**04-517**

E14, 2 x max. 28W

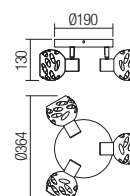
**04-518**

E14, 3 x max. 28W





**Series of interior light fittings, metal structure electrostatically painted in mat black with antique copper details.**



04-499

RO - Serie de corpuri de iluminat pentru interior, structură metalică vopsită electrostatic în negru mat cu detalii de cupru antichizat.

IT - Serie di lampade per interni, struttura in metallo verniciato elettrostaticamente in nero opaco con dettagli in rame antico.

RU - Серия светильников для внутреннего освещения, металлическая структура, окрашенная в электростатическом поле в матово-черный цвет с элементами античной меди.

HU - Beltéri lámpa testek, elektrosztatikus mezőben matt feketére festett fémszerkezet antik réz betéttel.

BG - Интериорни осветителни тела, корпус от метал, боядисан в черен мат с детайли в цвят античен мед.

SK - Série interiérových svietidiel, kovová štruktúra lakovaná v matnej čiernej farbe s detailami v antickej medenej farbe.



04-502

04-499



04-502

04-501

04-500

INFO/DIMENSIONS

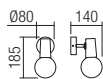

**04-499**

E27, 1 x max. 42W

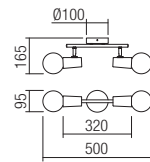

**04-500**

E27, 2 x max. 42W

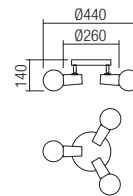

**04-501**

E27, 3 x max. 42W

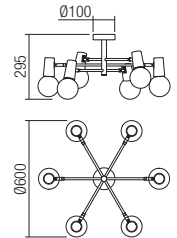

**04-502**

E27, 6 x max. 42W



# Magis



**Series of lamps for interior, structure of metal with mat black finishing and chromed detail or chromed metal with mat black details, shades of chromed glass with linear transparent decorations. Bulbs not included.**

RO · Serie de lămpi pentru interior, structură din metal negru mat cu ornament cromat sau din metal cromat cu detalii negru mat, abajururi din sticlă cromată cu decor liniar transparent. Becurile nu sunt incluse.

IT · Serie di apparecchi per interni, struttura in metallo finitura nero opaco con ornamento cromato o in metallo cromato con dettagli finitura nero opaco, diffusori in vetro cromato con decoro lineare trasparente. Lampadine non incluse.

RU · Серия светильников для интерьера, металлическая структура в матово-черной отделке с хромированными деталями, абажуры из хромированного стекла с прозрачными линейными украшениями. Лампы не входят в комплект.

HU · Beltéri lámpatestek, matt fekete fémszerkezet króm díszítéssel vagy króm fémszerkezet matt fekete díszítéssel, áttetsző öveg lineárisan króm szíszítéssel. Az izzó nem tartozék.

BG · Серия от интериорни осветителни тела, метална основа с чернен матов завършек и хромни детайли или хромиран метал с черни матови детайли. Абажур от хромно стъкло с линейни прозрачни декорации. Лампите не са включени.

SK · Sérija svietidiel pre interiér, konštrukcia kovu s matnou čiernou úpravou a chrómované detaily alebo pochrómovaný kov s matnými čiernymi detailmi, tienidlá chrómového skla s lineárnymi priehľadnými dekoráciami. Žiarovky nie sú súčasťou balenia.



04-482





04-481

04-480

04-479

INFO/DIMENSIONS

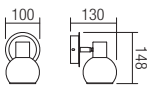

04-479

E14, 1 x max. 28W

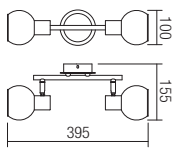

04-480

E14, 2 x max. 28W

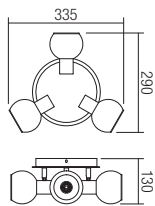

04-481

E14, 3 x max. 28W

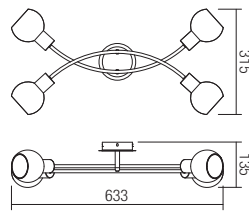

04-482

E14, 4 x max. 28W



# Amber



Series of lamps for interior, metal structure with mat black finishing, transparent amber glass shades. Bulbs not included.

RO · Serie de corpuri de iluminat pentru interior, structură din metal finisat negru mat, abajururi din sticlă ambră transparentă. Becurile nu sunt incluse.

IT · Serie di apparecchi per interni, struttura in metallo finitura nero opaco, diffusori in vetro ambrà trasparente. Lampadine non incluse.

RU · Серия светильников для интерьера, структура из металла окрашенного в черный матовый цвет, абажуры из прозрачного янтарного стекла. Лампы не входят в комплект.

HU · Beltéri lámpatestek, matt fekete fémszerkezet, áttetsző borostyán üveg. Az izzó nem tartozék.

BG · Серия от интериорни осветителни тела, метална основа с черен матов завършек, абажур от прозрачно кехлибарено стъкло. Лампите/крушките не са включени.

SK · Sériá svietidiel pre interiér, konštrukcia kovu s matnou čiernou povrchovou úpravou, priehľadné tienidlá z jantárového skla. Žiarovky nie sú súčasťou balenia.



04-485



04-484

## INFO/DIMENSIONS

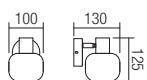

04-483

E14, 1 x max. 28W

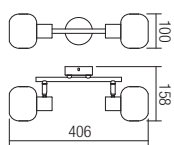

04-484

E14, 2 x max. 28W

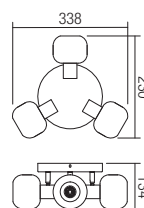

04-485

E14, 3 x max. 28W

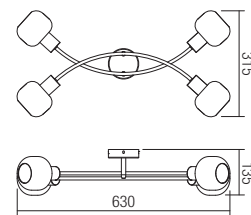

04-486

E14, 4 x max. 28W





04-486



04-483



# Bowie



**Series of light fitting for interior, metal structure with antique gold finishing and natural wood resembling painted decorations, transparent amber glass shades. Bulbs not included.**

RO · Serie de corpuri de iluminat pentru interior, structură din metal finisat aur antichizat cu decorațiuni vopsite tip lemn natur, abajururi din sticlă ambră transparentă. Becurile nu sunt incluse.

IT · Serie di apparecchi, struttura in metallo finitura oro anticato con decori verniciati tipo legno naturale, paralumi in vetro ambrà trasparente. Lampadine non incluse.

RU · Серия светильников для интерьера, структура из металла отделанного под состаренное золото с украшениями под натуральное дерево, абажуры из прозрачного янтарного стекла. Лампы не входят в комплект.

HU · Beltéri lámpatestek, antikolt arany fémszerkezet natur fa utánzatú díszítéssel, áttetsző borostyán üveg. Az izzó nem tartozék.

BG · Серия от интериорни осветителни тела, метална основа със завършек в състарено злато и натурално дърво, наподобяващо рисувани декорации. Абажур от прозрачно кехлибарено стъкло. Лампите/крушките не са включени.

SK · Sériá svietidiel pre interiér, kovová konštrukcia so starožitným zlatom a prírodným drevom pripomínajúcim maľované dekorácie, priehľadné tienidlá z jantárového skla. Žiarovky nie sú súčasťou balenia.



04-477



04-475

## INFO/DIMENSIONS

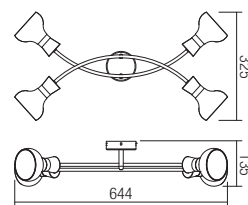
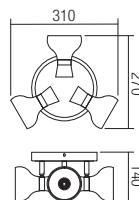
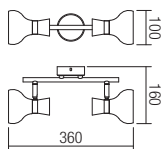
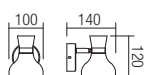

04-475

E14, 1 x max. 28W



04-476

E14, 2 x max. 28W



04-477

E14, 3 x max. 28W



04-478

E14, 4 x max. 28W





04-478



04-476

# Tom

Series of light fittings for interior, metal structure finished in wenge, white alabaster glass lampshades.

RO · Serie de corpuri de iluminat pentru interior, structură din metal finisat wenge, abajururi din sticlă tip alabastru alb.

IT · Serie di lampade per interni, struttura in metallo finitura wenge, paralumi in vetro alabastro bianco.

RU · Серия светильников для внутреннего освещения, металлическая конструкция с отделочным слоем венге, стеклянные абажуры типа белого алебаstra.

HU · Beltéri világítótest sor, wenge kikészítésű fémszerkezettel, kékesfehér üveg lámpaernyőkkel.

BG · Серия интериорни осветителни тела, структура от метал с покритие венге, абажури от стъкло тип синьо бяло.

SK · Rad svetidiel pre interiér, konštrukcie z kovu Wenge, tienidlo biele alabastrové sklo.



04-436



04-437

## INFO/DIMENSIONS

**04-436**

E14, 1 x max. 28W

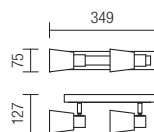
**04-437**

E14, 2 x max. 28W

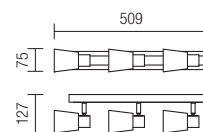
**04-438**

E14, 3 x max. 28W

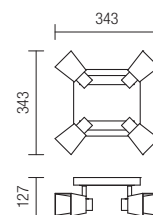
**04-439**

E14, 4 x max. 28W





04-439



04-438

# Glam



**Series of light fittings for interior, chromed metal structure and diffusers of chromed metal braiding with glass decorations**

RO · Serie de corpuri de iluminat pentru interior, structură din metal cromat și dispersoare din împletitură metalică cromată, cu decorațiuni din sticlă.

IT · Serie di apparecchi per interni, struttura in metallo cromato, diffusori in rete metallica cromata con decorazioni in vetro.

RU · Серия светильников для внутреннего освещения, металлическая хромированная структура, диффузоры из металлической хромированной оплетки со стеклянными украшениями.

HU · Beltéri világítótestek sorozata, krómozott fémszerkezet és krómozott fémes fonat diszperzórok, üveg díszítőelemekkel.

BG · Серия интериорни осветителни тела, структура от хромиран метал и разсейватели от хромирана метална плетка, със стъквени украшения.

SK · Rad svetidiel pre interiér, chrómová kovová konštrukcia a pochrómovaný kov so sklenenými ozdobami.



04-373



04-372



04-375





04-374

INFO/DIMENSIONS

<p><b>04-372</b></p>	<p><b>04-373</b></p>	<p><b>04-374</b></p>	<p><b>04-375</b></p>
<p>E14, 1 x max. 28W</p>	<p>E14, 2 x max. 28W</p>	<p>E14, 3 x max. 28W</p>	<p>E14, 5 x max. 28W</p>